

EXAMINED BY: <i>Jony Chen</i>	MITSU TECH INTERNATIONAL CORPORATION	FILE NO . CAS-10184
APPROVED BY: <i>David Chang</i>		ISSUE : DEC.01,1999
		TOTAL PAGE : 7
		VERSION : 2

CUSTOMER ACCEPTANCE SPECIFICATIONS

MODEL NO. :

20400 (LED TYPES)

FOR MESSRS :

CUSTOMER'S APPROVAL

DATE :

BY :

NUMBERING SYSTEM

Polarizer Mode	Backlight	Code value
Transflective	LED	L
Transmissive	LED	M

Backlight Color	Code Value
Yellow-Green	Y

E	W	2	0	4	0	0	G	L	Y
---	---	---	---	---	---	---	---	---	---

LCD type + color	Code Value
STN + Yellow-Green	Y
STN + Gray	G
STN + Blue	B

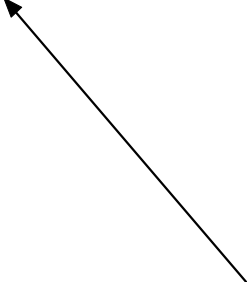
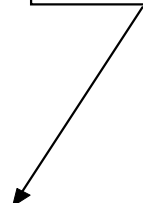
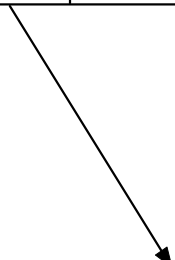

TABLE OF CONTENTS

NO.	ITEM	PAGE
=====		
1.	GENERAL SPECIFICATIONS -----	1
2.	MECHANICAL SPECIFICATIONS -----	1
3.	ABSOLUTE MAXIMUM RATINGS -----	2
4.	ELECTRICAL CHARACTERISTICS -----	3
5.	OPTICAL CHARACTERISTICS -----	3
6.	OUTLINE DIMENSION -----	4
7.	DETAIL DRAWING OF DOT MATRIX -----	5
8.	BLOCK DIAGRAM -----	5
9.	INTERFACE SIGNALS -----	6
10.	POWER SUPPLY -----	7
11.	DISPLAY DATA RAM ADDRESS -----	7

1. GENERAL SPECIFICATIONS

1.1 GENERAL SPECIFICATIONS

PLEASE REFER TO :

CUSTOMER ACCEPTANCE STANDARD SPECIFICATIONS :

E U - 0 0 2 A

1.2 APPLICATION NOTES FOR CONTROLLER / DRIVER :

PLEASE REFER TO :

CUSTOMER ACCEPTANCE STANDARD SPECIFICATIONS :

E U - K S 0 0 6 6

1.3 THIS INDIVIDUAL SPECIFICATIONS IS PRIOR TO GENERAL SPECIFICATIONS .

2. MECHANICAL SPECIFICATIONS

- (1) NUMBER OF CHARACTER ----- 20 CH * 4 LINES
- (2) MODULE SIZE ----- 98.0W * 60.0H * 14.0D (max.) mm
- (3) EFFECTIVE AREA ----- 76.0W * 25.2H mm
- (4) CHARACTER FONT ----- 5 * 7 DOTS + CURSOR
- (5) CHARACTER SIZE ----- 2.95W * 4.75H mm
- (6) CHARACTER PITCH ----- 3.55W * 5.35H mm
- (7) DOT SIZE ----- 0.55W * 0.55H mm
- (8) DOT PITCH ----- 0.60W * 0.60H mm
- (9) LCD TYPE *
- (10) DRIVING METHOD ----- 1 / 16 DUTY MULTIPLEX DRIVE
- (11) BACK - LIGHT *

* PLEASE REFER TO NUMBERING SYSTEM

3. ABSOLUTE MAXIMUM RATINGS

3.1 ELECTRICAL ABSOLUTE MAXIMUM RATINGS . (AT Ta = 25 °C)

PARAMETER	SYMBOL	MIN .	MAX .	UNIT	REMARK
POWER SUPPLY FOR LOGIC	VDD - VSS	0	7.0	V	
POWER SUPPLY FOR LCD DRIVE	VDD - VO	0	13.0	V	
INPUT VOLTAGE	VI	VSS	VDD	V	
STATIC ELECTRICITY	—	—	100	V	NOTE (1)
LED POWER DISSIPATION	PD	—	2.6	W	
LED FORWARD CURRENT	IF	—	560	mA	
LED REVERSE VOLTAGE	VR	—	8	V	

NOTE (1) : TEST METHOD AND CONDITIONS :
 AFTER CHARGING UP 200 PF CAPACITOR BY STATED VOLTAGE ,
 THE CAPACITOR IS CONNECTED WITH INTERFACE PINS OF THE
 MODULE .

3.2 ENVIRONMENTAL ABSOLUTE MAXIMUM RATINGS .

I T E M	OPERATING		STORAGE		REMARK
	MIN .	MAX .	MIN .	MAX .	
AMBIENT TEMPERATURE	-20 °C	70 °C	-30 °C	80 °C	NOTE (2) , (3)
HUMIDITY	—	90 % RH	—	90 % RH	WITHOUT CONDENSATION
VIBRATION	—	4.9 m/s ² (0.5 G)	—	19.6 m/s ² (2 G)	
SHOCK	—	29.4 m/s ² (3 G)	—	490.0 m/s ² (50 G)	XYZ DIRECTIONS
CORROSIVE GAS	NOT ACCEPTABLE		NOT ACCEPTABLE		

NOTE (2) : Ta AT -30°C : 48HR MAX .
 80°C : 168HR MAX .

NOTE (3) : BACKGROUND COLOR CHANGES SLIGHTLY DEPENDING ON AMBIENT
 TEMPERATURE THIS PHENOMENON IS REVERSIBLE .

4. ELECTRICAL CHARACTERISTICS

Ta = 25°C

VDD = 5.0 ± 0.25 V

PARAMETER	SYMBOL	CONDITION	MIN .	TYP .	MAX .	UNIT
H LEVEL INPUT VOLTAGE	VIH	—	2.2	—	—	V
L LEVEL INPUT VOLTAGE	VIL	—	—	—	0.6	V
H LEVEL OUTPUT VOLTAGE	VOH	−IOH = 0.2 mA	2.4	—	—	V
L LEVEL OUTPUT VOLTAGE	VOL	IOL = 1.2 mA	—	—	0.4	V
POWER SUPPLY CURRENT (LOGIC)	IDD	VDD = 5.0 V	—	2.0	5.0	mA
RECOMMENDED LCD DRIVING VOLTAGE	VDD - VO	Ta = -20 °C	—	4.4	—	V
	∅ = 10°, θ = 0°	Ta = 25 °C	—	4.4	—	V
	DUTY = 1/16	Ta = 70 °C	—	4.4	—	V
CLOCK OSCILLATION FREQUENCY	fosc	Ta = 25 °C	—	270	—	KHZ
LED FORWARD VOLTAGE	VF	IF = 280 mA	—	4.2	4.6	V
LED FORWARD CURRENT	IF	—	—	280	—	mA
LED REVERSE CURRENT	IR	VR = 8 V	—	—	280	μA

5. OPTICAL CHARACTERISTICS .

Ta = 25 °C

VDD = 5.0 V

ITEM	SYMBOL	CONDITION	MIN .	TYP .	MAX .	UNIT	NOTE	
VIEWING AREA	∅ 2 - ∅ 1	K ≥ 1.4	3.0	—	—	deg.	1	
CONTRAST RATIO	K	∅ = 10° θ = 0°	5	—	—	—	1	
RESPONSE TIME	tr (rise)	∅ = 10° θ = 0°	Ta = -20°C	—	5538	—	ms	1
			Ta = 25°C	—	228	—		
	Ta = 70°C		—	104	—			
	tf (fall)		Ta = -20°C	—	2316	—		
			Ta = 25°C	—	174	—		
	Ta = 70°C	—	85	—				
THE BRIGHTNESS OF BACK- LIGHT	L	IF = 240 mA	—	35	—	cd/m ²	1, 2	
			—	75	—		1, 3	
PEAK EMISSION WAVELENGTH	λ P	IF = 240 mA	—	572	—	nm	1	

NOTE (1): PLEASE REFER TO :
CUSTOMER ACCEPTANCE STANDARD SPECIFICATION : EU-002A

NOTE (2): POLARIZER MODE : TRANSFLECTIVE

NOTE (3): POLARIZER MODE : TRANSMISSIVE

MODEL NO.	VERSION	PAGE
20400 (LED TYPES)	2	4

6. OUTLINE DIMENSION

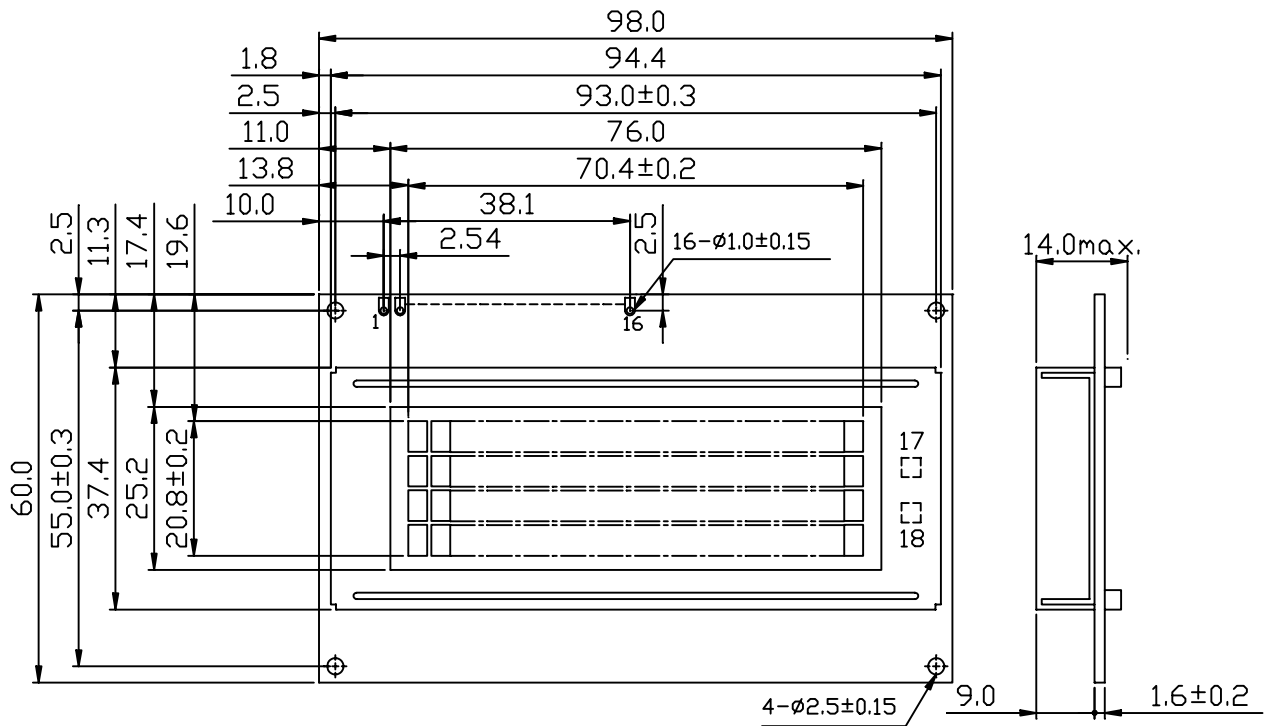

UNIT : mm
 SCALE : NTS
 NOT SPECIFIED TOLERANCE IS ± 0.5

7. DETAIL DRAWING OF DOT MATRIX

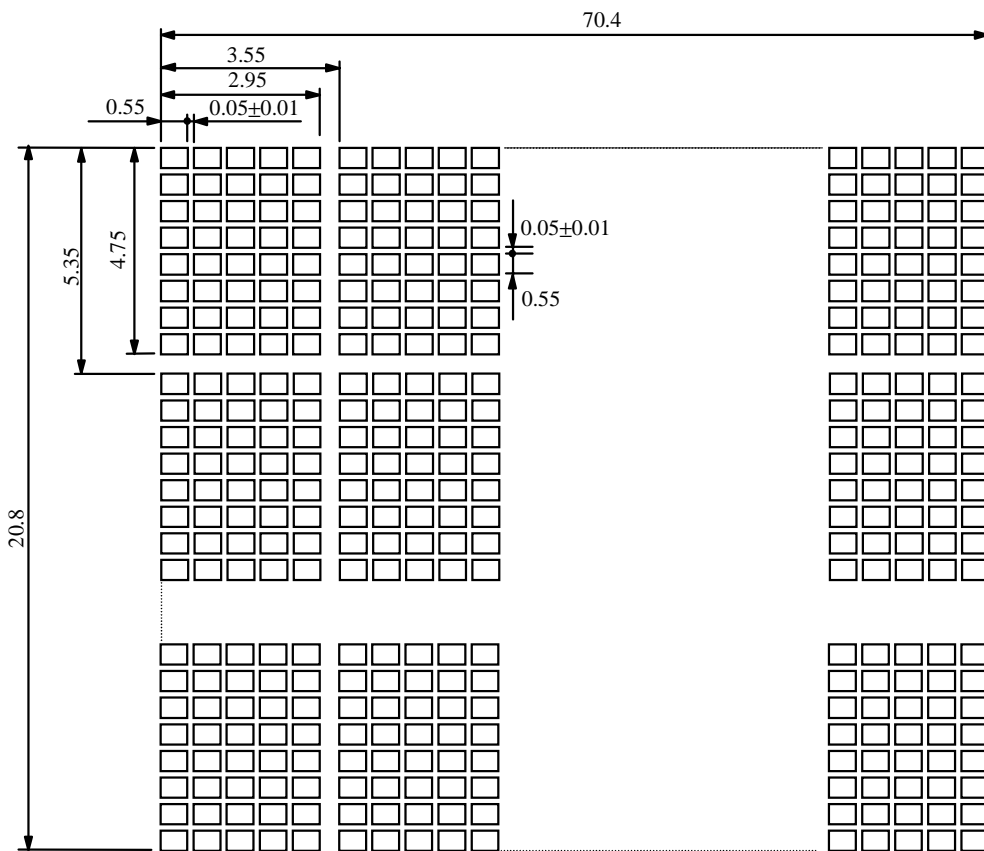

UNIT : mm
 SCALE : NTS
 NOT SPECIFIED TOLERANCE IS ± 0.1

8. BLOCK DIAGRAM

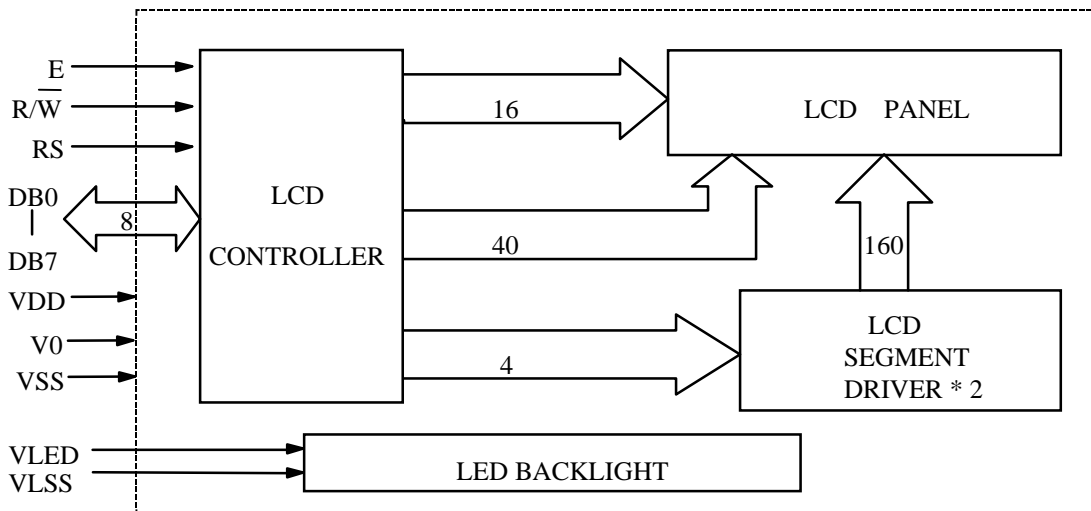

9. INTERFACE SIGNALS

PIN NO.	SYMBOL	DESCRIPTION	FUNCTION
1	VSS	GROUND	0V (GND)
2	VDD	POWER SUPPLY FOR LOGIC CIRCUIT	+5V
3	V0	LCD CONTRAST FOR LOGIC CIRCUIT	
4	RS	INSTRUCTION/DATA REGISTER SELECTION	RS = 0 : INSTRUCTION REGISTER RS = 1 : DATA REGISTER
5	$\overline{R/W}$	READ/WRITE SELECTION	$\overline{R/W}$ = 0 : REGISTER WRITE $\overline{R/W}$ = 1 : REGISTER READ
6	E	ENABLE INPUT	
7	DB0	DATA INPUT/OUTPUT LINES	4 BIT/8BIT SELECTABLE 4 BIT : DB4 - DB7 8 BIT : DB0 - DB7
8	DB1		
9	DB2		
10	DB3		
11	DB4		
12	DB5		
13	DB6		
14	DB7		
15	VLED	POWER SUPPLY FOR LED BACKLIGHT (ANODE)	
16	VLSS	POWER SUPPLY FOR LED BACKLIGHT (CATHODE)	0V (GND)
17	VLED	POWER SUPPLY FOR LED BACKLIGHT (ANODE)	
18	VLSS	POWER SUPPLY FOR LED BACKLIGHT (CATHODE)	0V (GND)

10. POWER SUPPLY

10.1 POWER SUPPLY FOR LCD MODULE

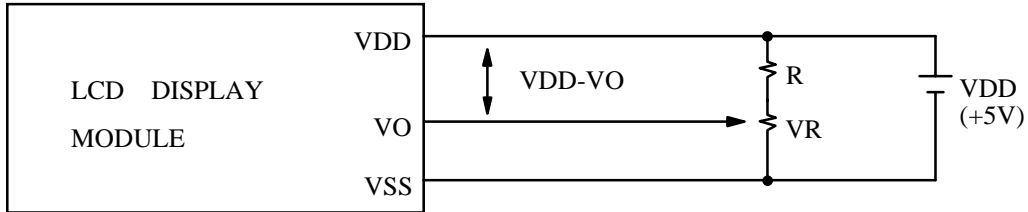

VDD - VO : LCD DRIVING VOLTAGE

VR : $10K\Omega \sim 20K\Omega$

RECOMMENDED RESISTOR R : $VDD - VO \geq 1.5 V$

10.2 POWER SUPPLY FOR LED BACKLIGHT

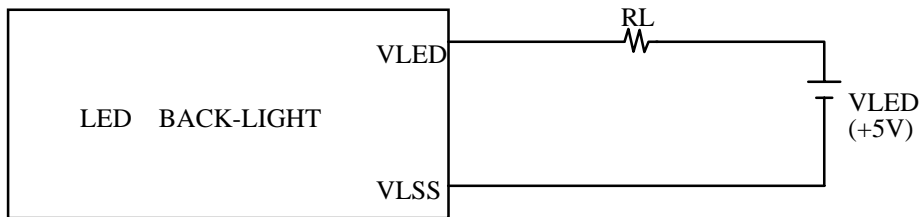

RECOMMENDED RESISTOR RL : $3 \sim 6.8 \Omega$, 1/2 WATT (CONTROLLED BY USER)

* THE BRIGHTNESS WOULD BE ALTERED SUBJECT TO DIFFERENT VALUES OF RL

11. DISPLAY DATA RAM ADDRESS

CHARACTER	1	2	3	4	5	6	7	8	9	10	11	12	13	14	15	16	17	18	19	20
LINE 1	80	81	82	83	84	85	86	87	88	89	8A	8B	8C	8D	8E	8F	90	91	92	93
LINE 2	C0	C1	C2	C3	C4	C5	C6	C7	C8	C9	CA	CB	CC	CD	CE	CF	D0	D1	D2	D3
LINE 3	94	95	96	97	98	99	8A	9B	9C	9D	9E	9F	A0	A1	A2	A3	A4	A5	A6	A7
LINE 4	D4	D5	D6	D7	D8	D9	DA	DB	DC	DD	DE	DF	E0	E1	E2	E3	E4	E5	E6	E7